

ASSEMBLY INSTRUCTION

# TRILOGY BUNK BED

BunkBed-533A



## SAFETY PRECAUTION



### **WARNING:**

**TOP BUNKS AND ELEVATED BEDS ARE DANGEROUS AND ARE NOT RECOMMENDED FOR CHILDREN UNDER THE AGE OF 9**

Falls from elevated beds can be fatal and deaths have occurred where children have fallen from elevated beds. This is relevant for all ages. The risk is greater for younger children.

The risk of injury or death from a fall from an elevated bed compared to a non-elevated bed is:

10 x greater for 7-8 year olds

7 x greater for 9-10 year olds

3 x greater for 11-12 year olds



### **WARNING:**

**THE UPPER BUNK MUST BE MORE THAN 2 M FROM ANY CEILING FAN.**

### **IMPORTANT:**

Do **NOT** STEP, SIT or JUMP on the SIDE RAIL & METAL BASE.

# SAFETY PRECAUTION

READ THESE INSTRUCTIONS CAREFULLY BEFORE ATTEMPTING TO ASSEMBLE THIS BED

## SAFETY WARNINGS AND GENERAL INSTRUCTIONS

- ✓ Follow the instruction on the **WARNING** labels on top bunk and the package.  
**DO NOT REMOVE THE LABELS FROM THE BED**
- ✓ Always use the recommended size mattress, mattress support, or both, to prevent the likelihood of entrapment or falls
- ✓ The top surface of the mattress must be at least 5 inches below the upper edge of the guardrails
- ✓ Weight Capacity on top bunk is 65kg
- ✓ **DO NOT** allow horseplay on the bunk bed. Always **PROHIBIT** jumping on the bed
- ✓ Children **SHOULD BE** discouraged from playing on the bunk bed
- ✓ Periodically check and ensure that the guardrail, access device and other components are maintained in the correct position and state of repair and that all connectors are tight
- ✓ **DO NOT** use any substitute parts. Contact the manufacturer or dealer for replacement parts
- ✓ **STRANGULATION HAZARD** - Never attach or hang items to any part of the bunk that are not designed for use with the bed, but not limited to hooks, belts, or jump ropes
- ✓ Keep these instructions in a safe place for future reference

# EXPLODED VIEW

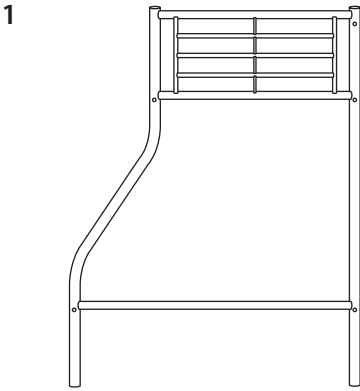

Left & Right Bed Metal Frame X 1pc

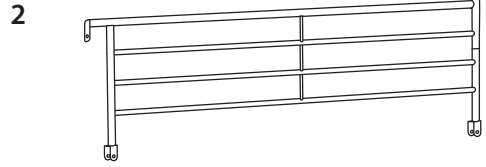

Front Safety Rail X 1pc

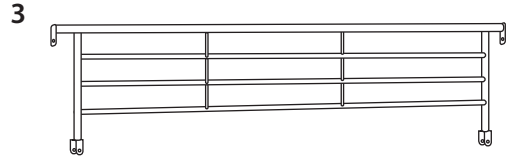

Back Safety Rail X 1pc

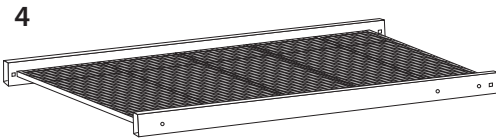

Upper Bed Base X 1pc

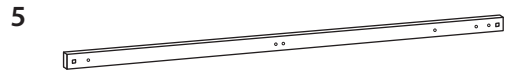

Bottom Side Rail X 2pcs

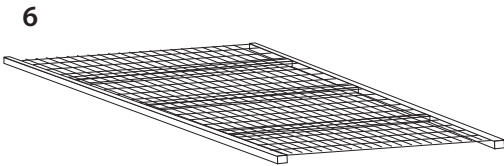

Bottom Bed Base X 2pcs

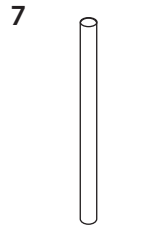

19mm Ladder Support Pipe X 3pcs

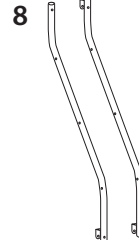

25mm Ladder Pipe X 2pcs

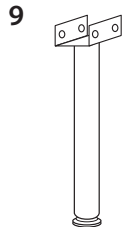

Adjustable Support Leg X 2pcs

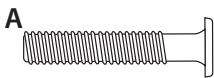

M8 X 110mm JCBC Screw X 8pcs

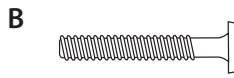

M6 X 50mm JCBC Screw X 11pcs



M6 X 40mm JCBC Screw X 14pcs



M6 X 25mm JCBC Screw X 3pcs

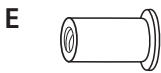

M6 X 12mm JCN Nut X 14pcs

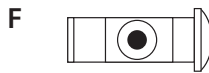

M8 x 32 Metal Square Nut X 8pcs



25mm x 50mm Rectangular Plastic Connector X 8pcs



50mm Round Plastic Cap X 4pcs



50mm Round Plastic Stopper X 4pcs



M5 Allen Key X 1pc









M4 Allen Key X 2pcs

# ASSEMBLY INSTRUCTIONS

## STEP 1:

Insert Plastic Stoppers (I) into the bottom of the Left and Right Bed Metal Frames (1), and insert Round Plastic Caps (H) into the top of the Frames (1).

Use Screws (A), Plastic Connectors (G), and Metal Square Nuts (F) to secure the Frames with Bottom Side Rails (5) and Upper Bed Base(4).

Accessories	
	<b>A</b> M8 X 110mm JCBB Screw X 8pcs
	<b>F</b> M8 x 32 Metal Square Nut X 8pcs
	<b>G</b> 25mm x 50mm Rectangular Plastic Connector X 8pcs
	<b>H</b> 50mm Round Plastic Cap X 4pcs
	<b>I</b> 50mm Round Plastic Stopper X 4pcs
	<b>J</b> M5 Allen Key X 1pc

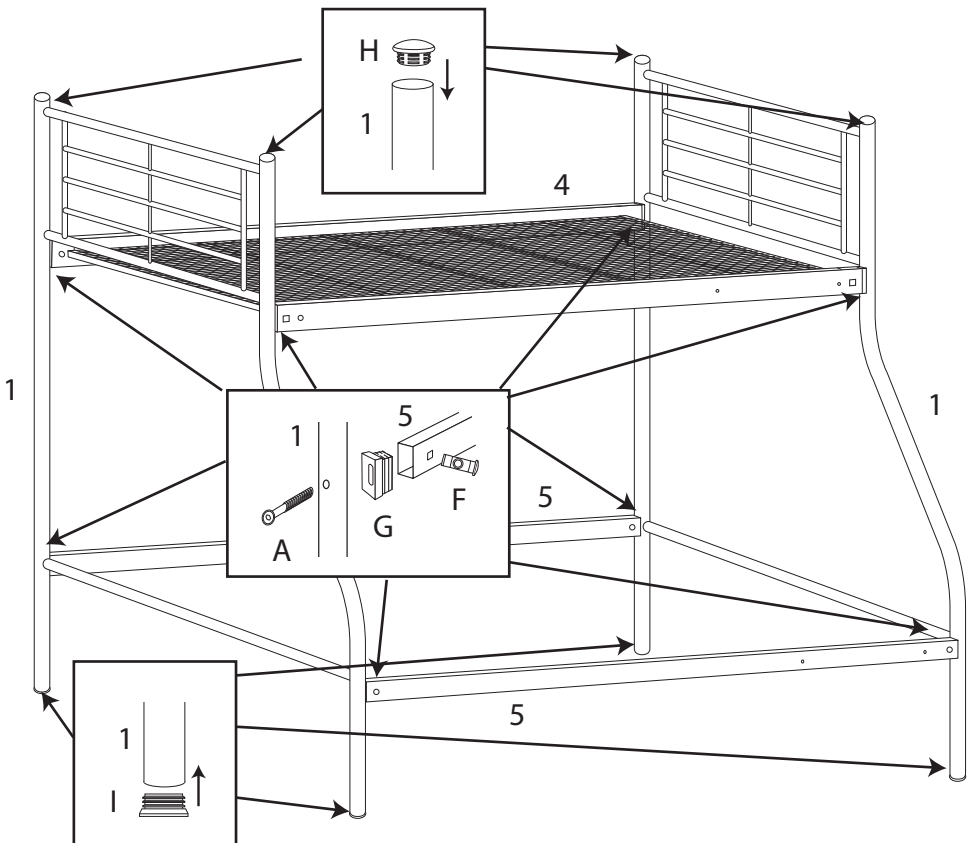



# ASSEMBLY INSTRUCTIONS

## STEP 2:

Insert Screws (C) into the Bottom Bed Base (6), and secure the Bottom Bed Base with the Bottom Side Rails (5).

Put the Adjustable Support Legs (9) under the Bottom Bed Base, and use Screws (B) and Nuts (E) to secure them.

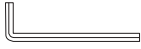

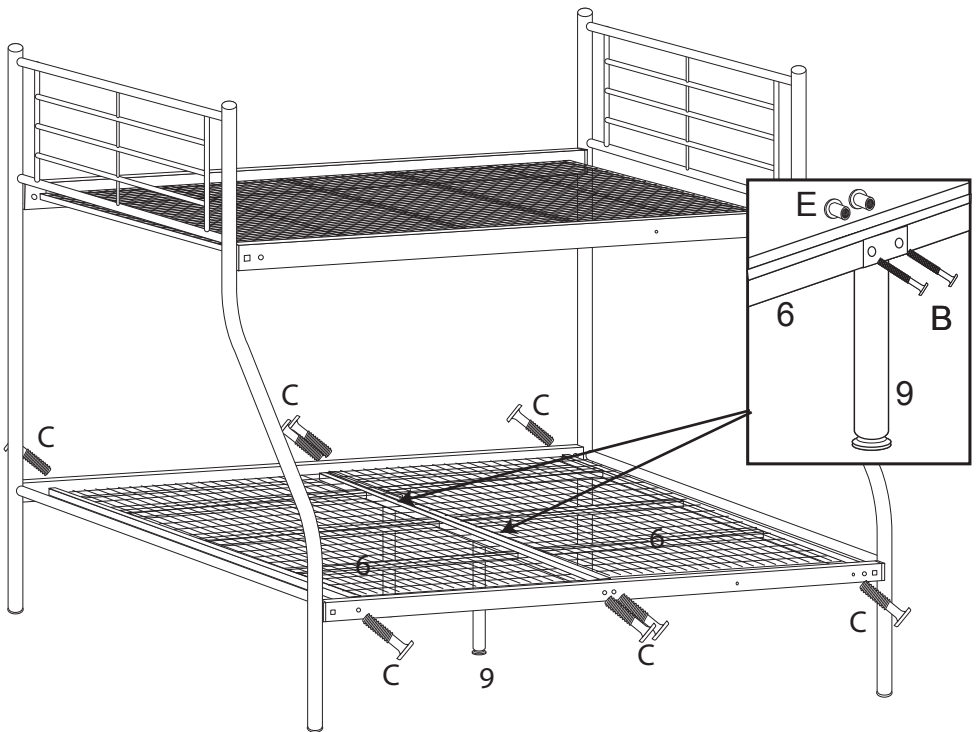

Accessories	
	<b>B</b> M6 X 50mm JCBC Screw X 4pcs
	<b>C</b> M6 X 40mm JCBC Screw X 8pcs
	<b>E</b> M6 X 12mm JCN Nut X 4pcs
	<b>K</b> M4 Allen Key X 2pcs



# ASSEMBLY INSTRUCTIONS

## STEP 3:

Put Nuts (E) and Screws (B) through the top of the Back Safety Rail (3); and Nuts (E) and Screws (D) through the bottom of the Back Safety Rails (3), to secure the Back Safety Rails with the frames.



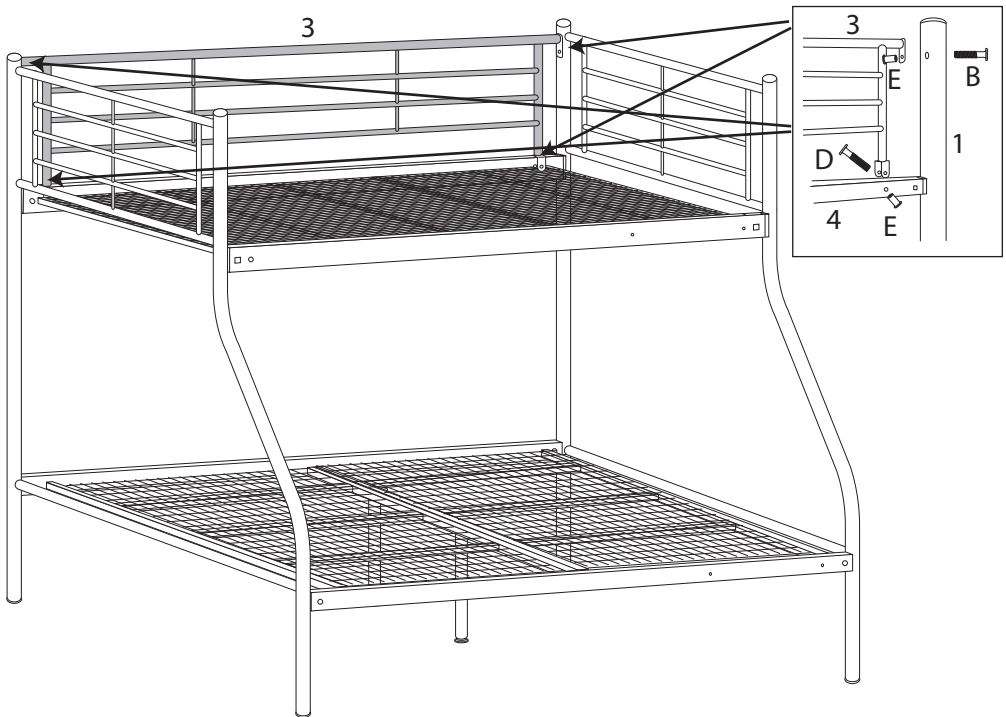

Accessories	
	<b>B</b> M6 X 50mm JCBC Screw X 2pcs
	<b>D</b> M6 X 25mm JCBC Screw X 2pcs
	<b>E</b> M6 X 12mm JCN Nut X 4pcs
	<b>K</b> M4 Allen Key X 2pcs



# ASSEMBLY INSTRUCTIONS

## STEP 4:

Use Screws (B & D) and Nuts (E) to secure the Front Safety Rail (2) with the Upper Bed Case. Connect the Ladder Support Pipes (7) and Ladder Pipes (8) with Screws (C). Use Nuts (E) and Screws (B) to secure the Ladder with the Upper and Lower Bed Base.

Accessories	
	<b>B</b> M6 X 50mm JCBC Screw X 5pcs
	<b>C</b> M6 X 40mm JCBC Screw X 6pcs
	<b>D</b> M6 X 25mm JCBC Screw X 1pcs
	<b>E</b> M6 X 12mm JCN Nut X 6pcs
	<b>K</b> M4 Allen Key X 2pcs

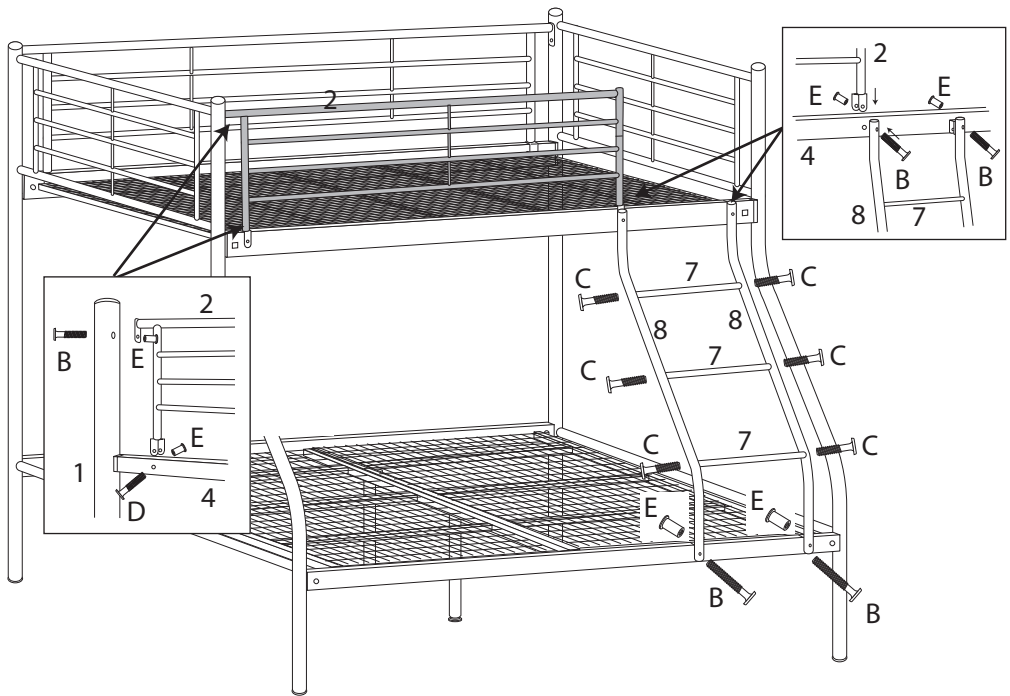



# Complete

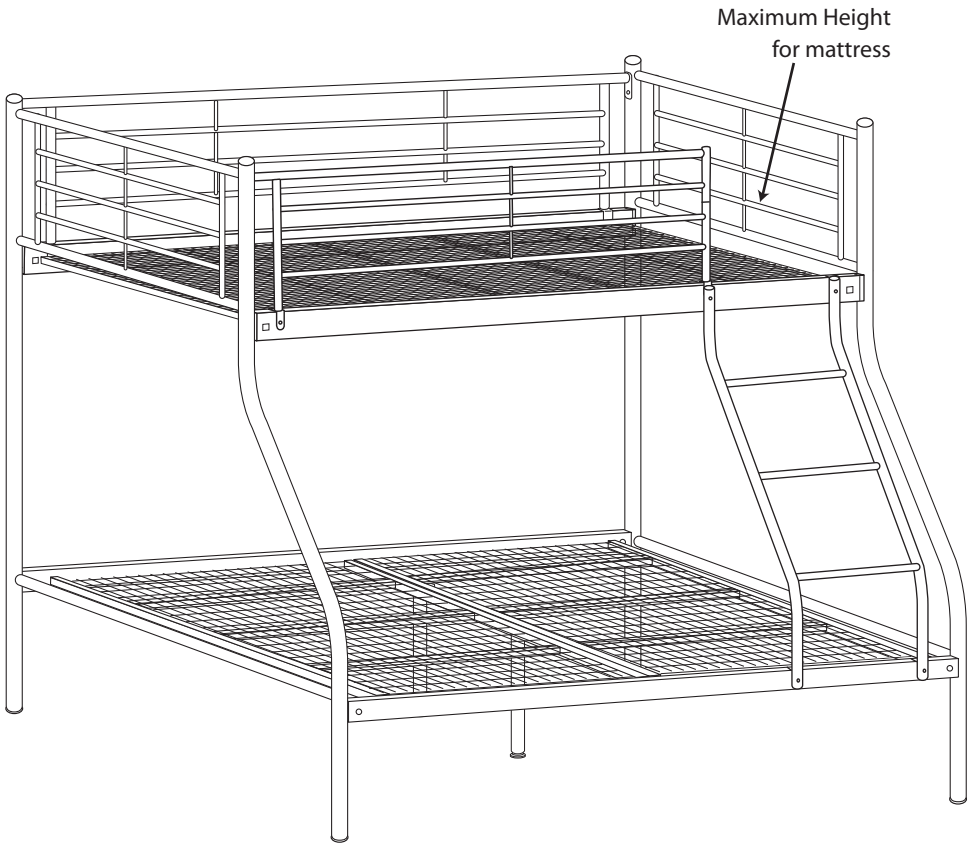

**IMPORTANT:** Do **NOT** STEP, SIT or JUMP on the SIDE RAIL & METAL BASE.